

#UP1026

Jeans miniskirt

Take your fashion game up a notch with this jeans miniskirt! It features the classic 5-pocket style, an uneven hem, a waistband with belt loops, and an alluring fitted cut. Although this is an advanced sewing project, the result is totally worth the effort as it has a timeless style that will last for years.

1 cm seam allowance included!

Front

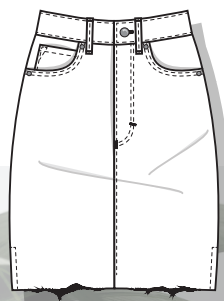

Back

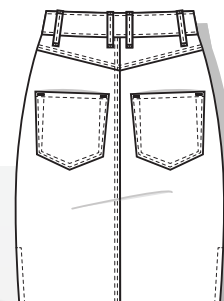

Material

- 110 x 150 cm of denim fabric
- 25 x 110 cm of light poplin or broadcloth
- 110 x 90 cm of fusible interfacing
- All-purpose thread
- Jeans needle (size 16-18)
- 1x zipper for pants (length 15 cm)
- 1x button (1.5 cm wide)
- OPTIONAL: topstitch thread
- OPTIONAL: 4x rivets (1 cm wide)

Print & Assemble

- First, be sure to use ACROBAT READER to open your PDF sewing patterns. It's free!
- Then, open your file and click on the LAYERS icon (left side of the screen) and uncheck all the sizes you won't need.
- Now, click on the PRINT icon at the top of the screen. The print settings will appear, so verify that the ACTUAL SIZE option is checked. Click on the PRINT button!
- A 5 x 5 cm (and 2 x 2") control square is provided to ensure that your pattern is true to size.
- To ASSEMBLE, cut the sheets at the bottom and right margins, as indicated. Each sheet is labelled with a letter and a number (A1, B2...), so tape them together in numerical and alphabetical order. The sheets on one row should have the same letter, and the ones on the same column should have the same number.

Sizing Guide

	XXS	XS	S	M	L	XL	XXL
Bust	85 cm	89 cm	93 cm	99 cm	105 cm	113 cm	121 cm
Waist	64 cm	68 cm	72 cm	78 cm	84 cm	92 cm	100 cm
Hips	92 cm	96 cm	100 cm	106 cm	112 cm	120 cm	128 cm

Garment measurements

- **Length:** 34.5 cm

This pattern is drafted according to a standard height of **1.64 m**.

#UP1026

Jeans miniskirt

Pattern Pieces

- Coin pocket, 1x fabric
- Pocket backing, 2x fabric
- Pocket lining, 2x lining
- Front, 2x fabric
- Fly shield, 1x fabric 1x interfacing
- Fly facing, 1x fabric 1x interfacing
- Back pocket, 2x fabric
- Back, 2x fabric
- Back yoke, 2x fabric
- Belt loop, 2x fabric
- Belt, 1x fabric 1x interfacing

Sewing Assembly

Unless otherwise specified, sew using a **1 cm** wide seam allowance.

1. Fuse the belt, fly shield, and fly facing.
2. Hem the top of the coin pocket (turn twice 1 cm) and sew it on the pocket backing, on the right-hand side of the garment.
3. Assemble the front pockets.
4. Sew the center front, leaving an opening above the notch.
5. Assemble the front fly and topstitch the center front.
6. Hem the top edge of the back pockets (turn twice 1 cm) and sew them to the back panels.
7. Sew the yokes to the back panels. Topstitch above the seams.
8. Sew the center back and topstitch it.
9. Sew the side seams, leaving an opening below the lower notches.
10. Sew the side slits.
11. Make the belt loop and cut the pieces to get six belt loops. Sew them on the top of the garment (see pattern for placement markings).
12. Sew the belt on the top of the garment.
13. Sew the belt loops to the top of the belt.
14. OPTIONAL: add a row of stitching roughly 1 cm above the raw hems to prevent them from fraying when washing.
15. Add the button and buttonhole (see pattern for placement).
16. OPTIONAL: install rivets on the front pocket openings.



Share a photo of you
wearing proudly
your new jeans skirt
with

#unfetteredpatterns!



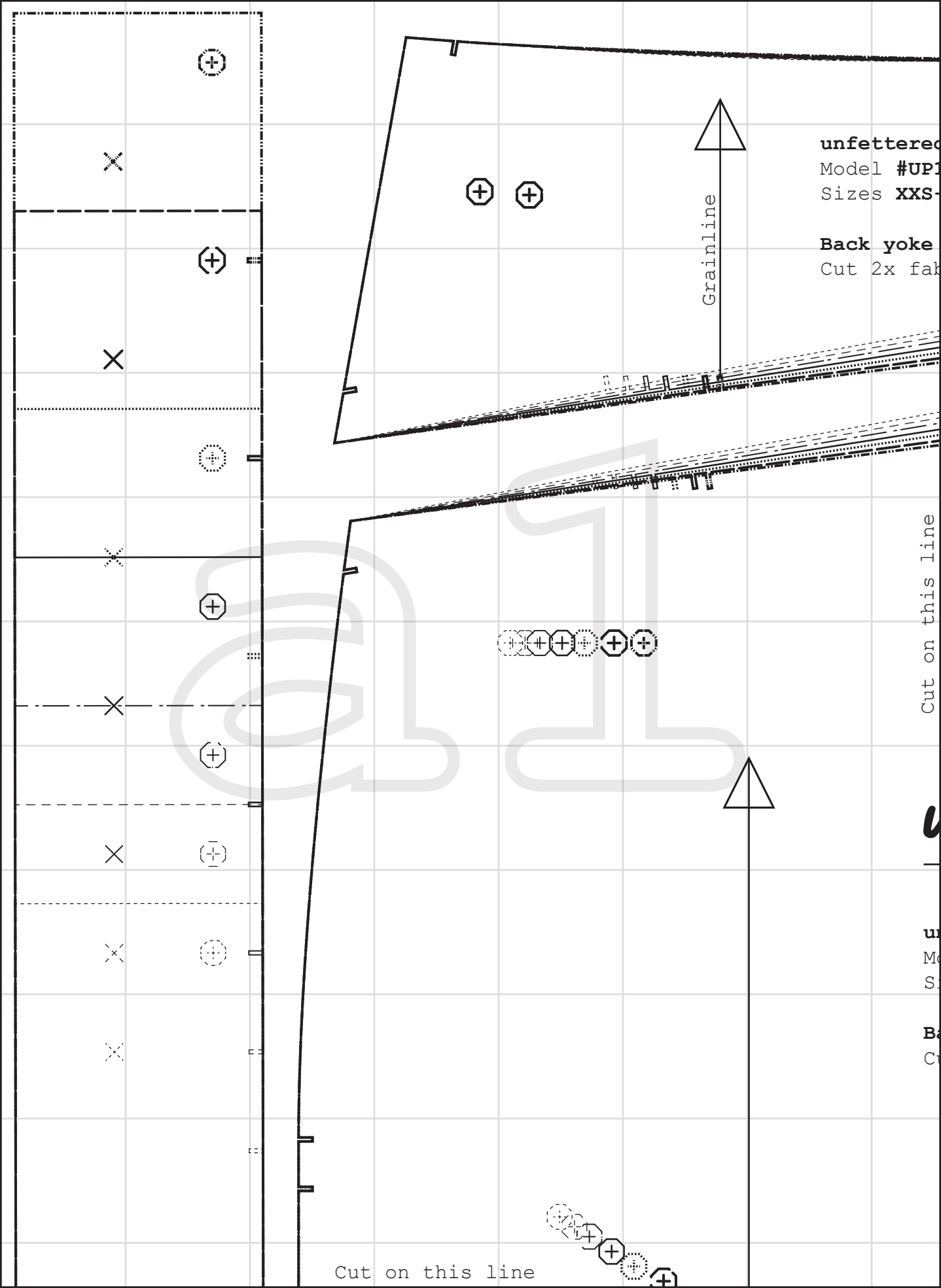

unfettered

Model #UP1

Sizes XXS-

Back yoke

Cut 2x fabric

Grainline

Cut on this line

Cut on this line

patterns.com

026

XXL

ric

Cut on this line



unfettered
—unfettered patterns—

unfetteredpatterns.com

odel #UP1026

izes XXS-XXL

ack

at 2x fabric



Cut on this line

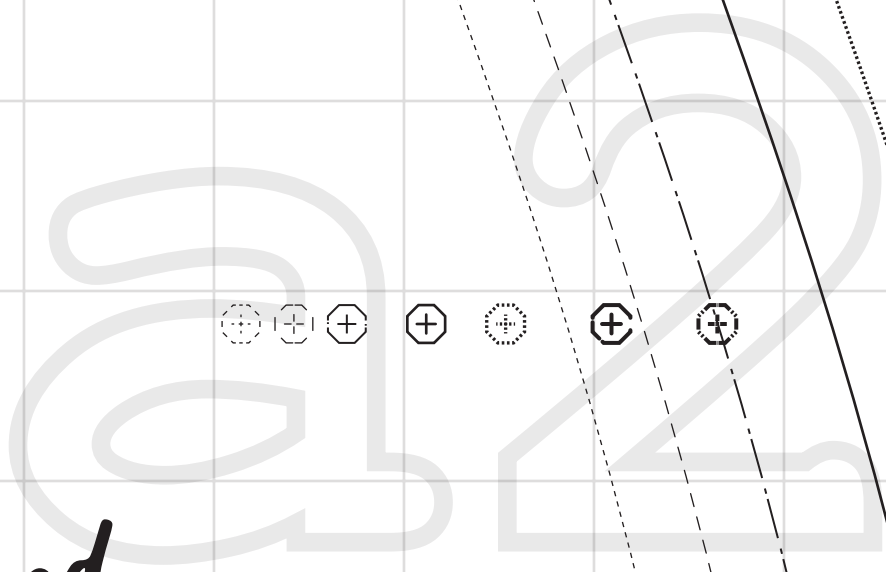



Grainline

unfetteredpatterns.com

Model #UP1026

Sizes **XXS-XXL**

Pocket backing

Cut 2x fabric

**Hem allowance
2 cm**

unfetteredpatterns.com

Model #UP1026

Sizes **XXS-XXL**

Coin pocket

Cut 1x fabric
(wrong side up)



Grainline

Cut on this line

unfetteredpatterns.com

Model #UP1026

Sizes **XXS-XXL**

Belt

Cut 1x fabric

Cut 1x interfacing

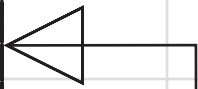

Cut on this line

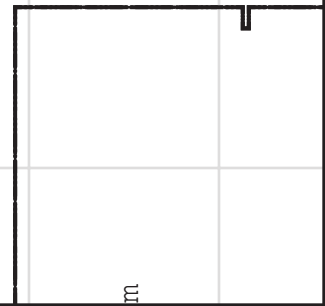
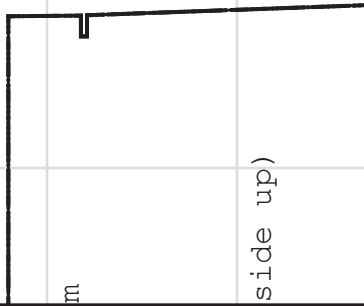
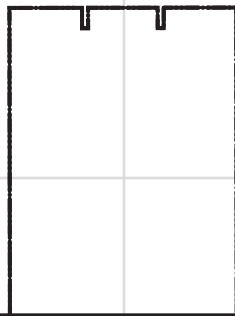

Grainline

Cut on this line

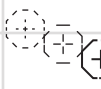



SIZE KEY

XXL	-----
XL	-----
L	-----
M	-----
S	-----
XS	-----
XXS	-----

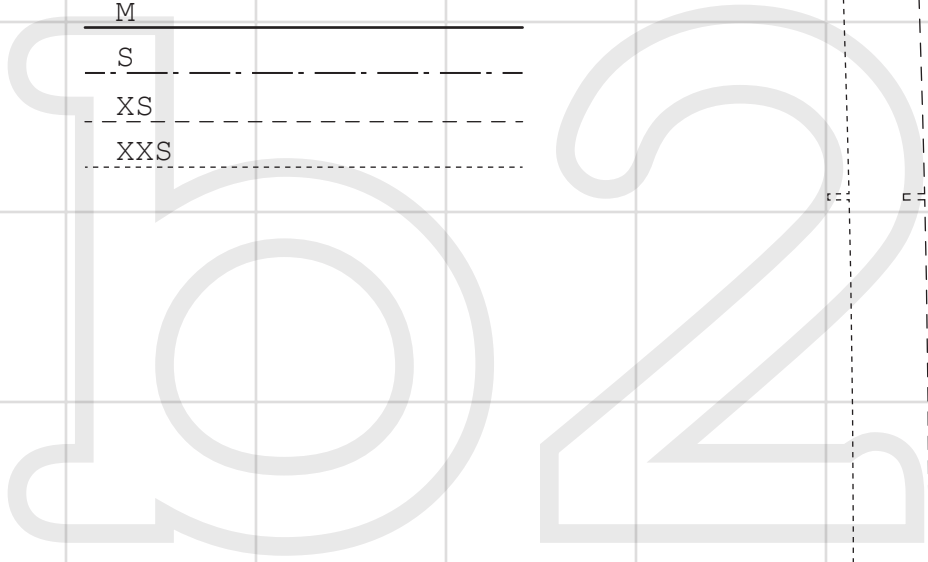

Cut on this line

Cut on this line

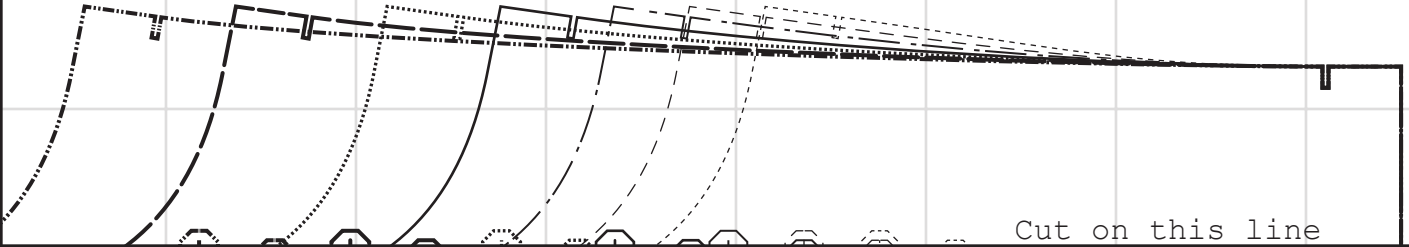
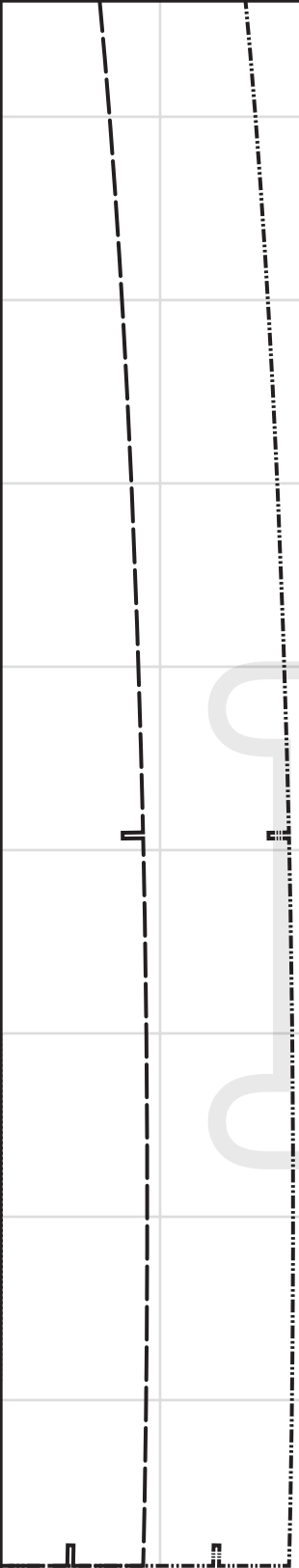
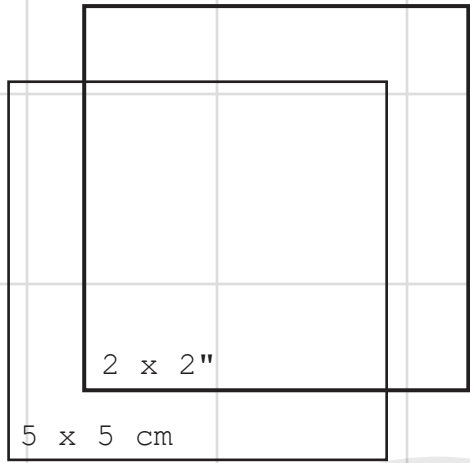
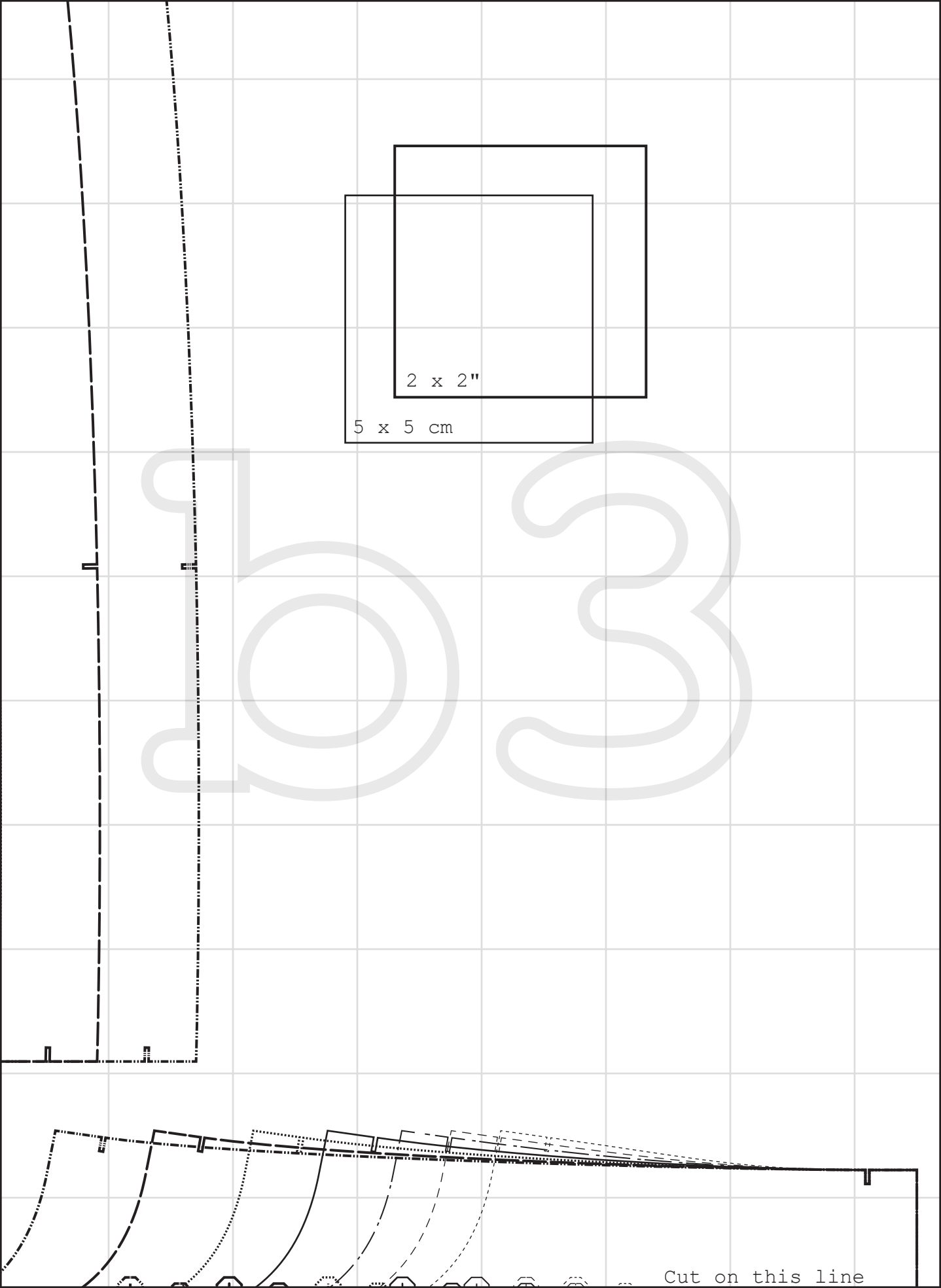

Cut on this line

on the fold of the fabric

Cut this edge



unfetteredpatterns.com
Model #UP1026
Sizes XXS-XXL

Belt loop

Cut 2x fabric



Grainline

unfetteredpatterns.com
Model #UP1026
Sizes XXS-XXL

Fly facing

Cut 1x fabric (wrong)
Cut 1x interfacing



Grainline

unfetteredpatterns.com
Model #UP1026
Sizes XXS-XXL

Fly shield

Cut 1x fabric

Grainline

Cut on this line

Cut on this line

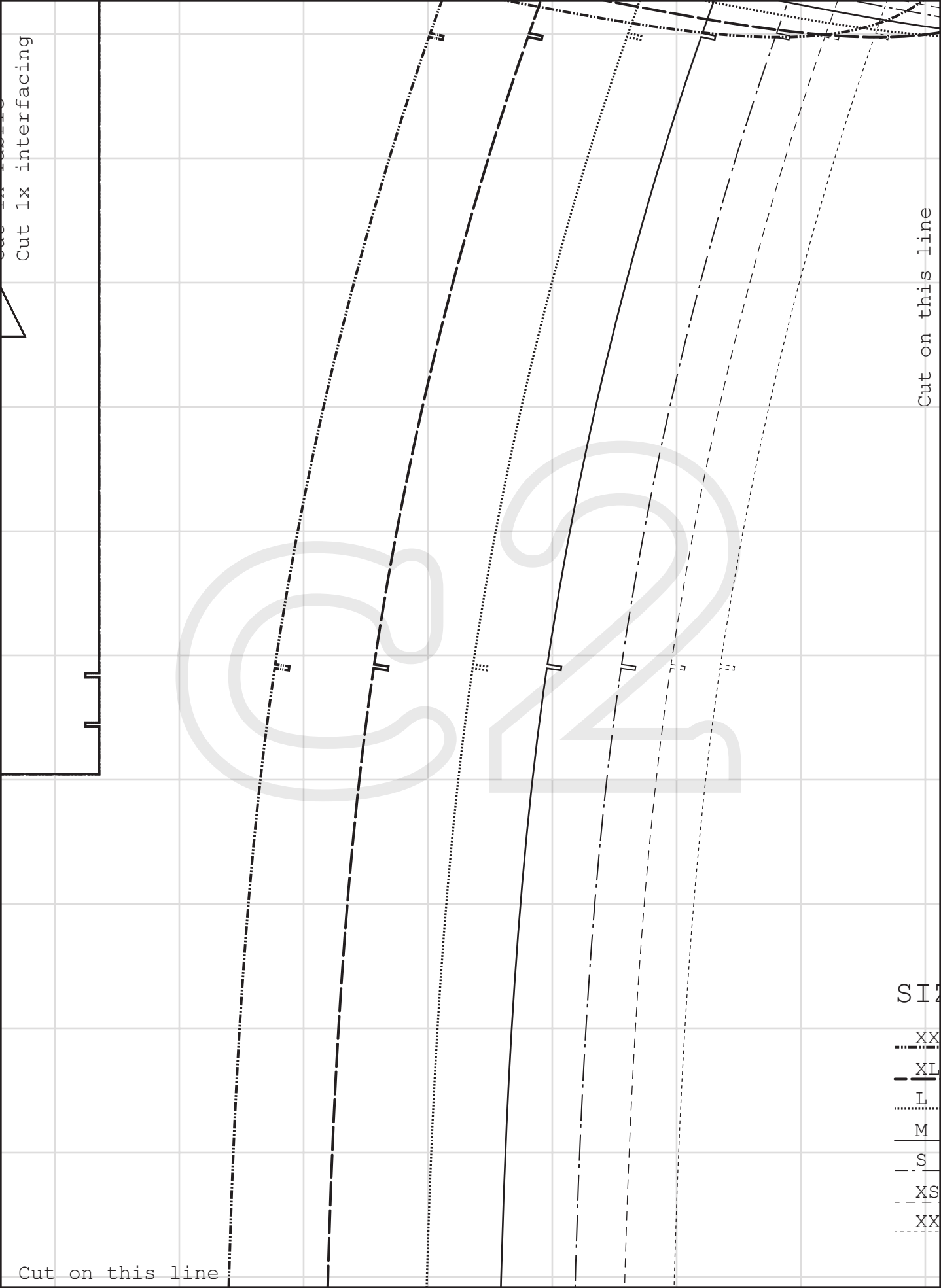

Cut 1x interfacing

Cut on this line

Cut on this line

- XX
- - - XL
- ... L
- ___ M
- - - S
- - - XS
- ... XX

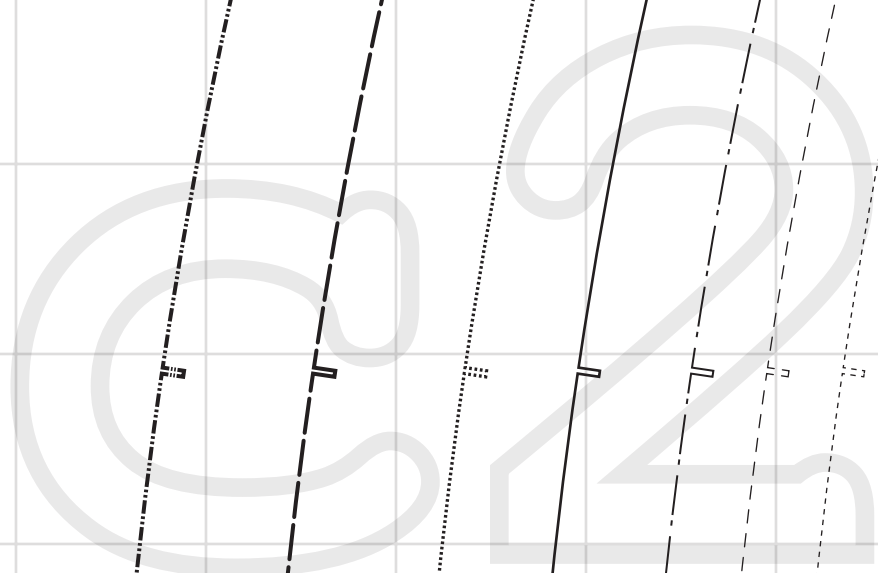

unfettered
— unfettered patterns —

unfetteredpatterns.com

Model #UP1026

Sizes **XXS-XXL**

Front

Cut 2x fabric

Grainline

SIZE KEY

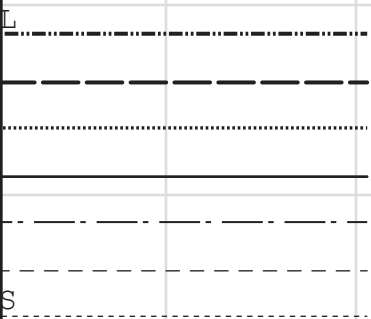

Cut on this line

Cut on this line

Hem all
2 c

unfettered
-unfettered

unfetteredpatt
Model #UP1026
Sizes **XXS-XXL**

Back
Cut 2x fabric

Grainline

Cut on this line

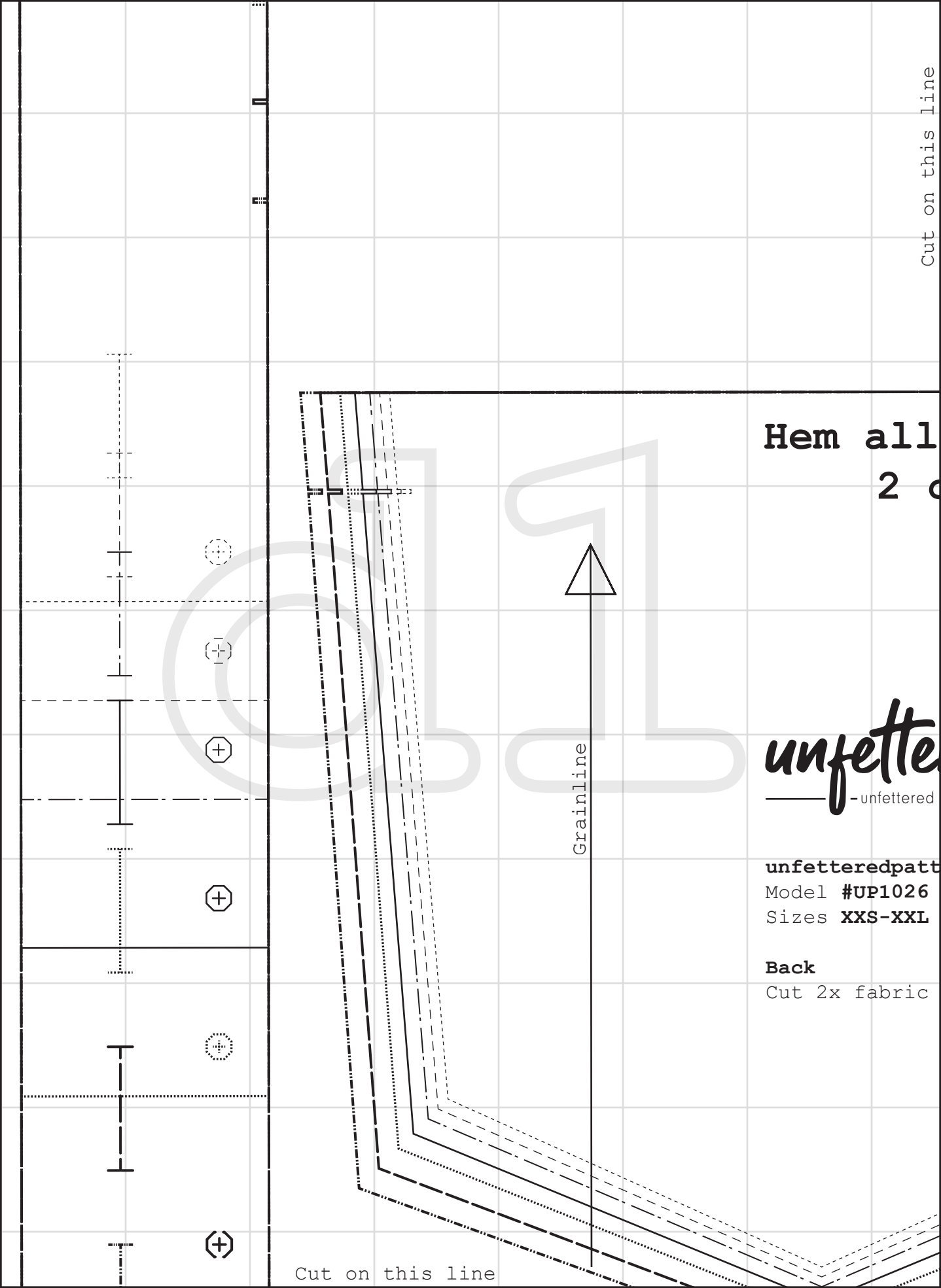

owance
cm

red
patterns

erns.com

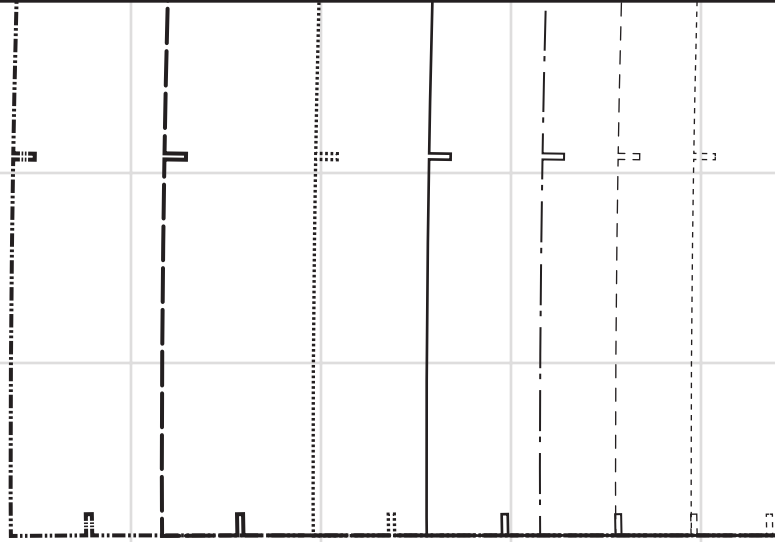

Cut on this line

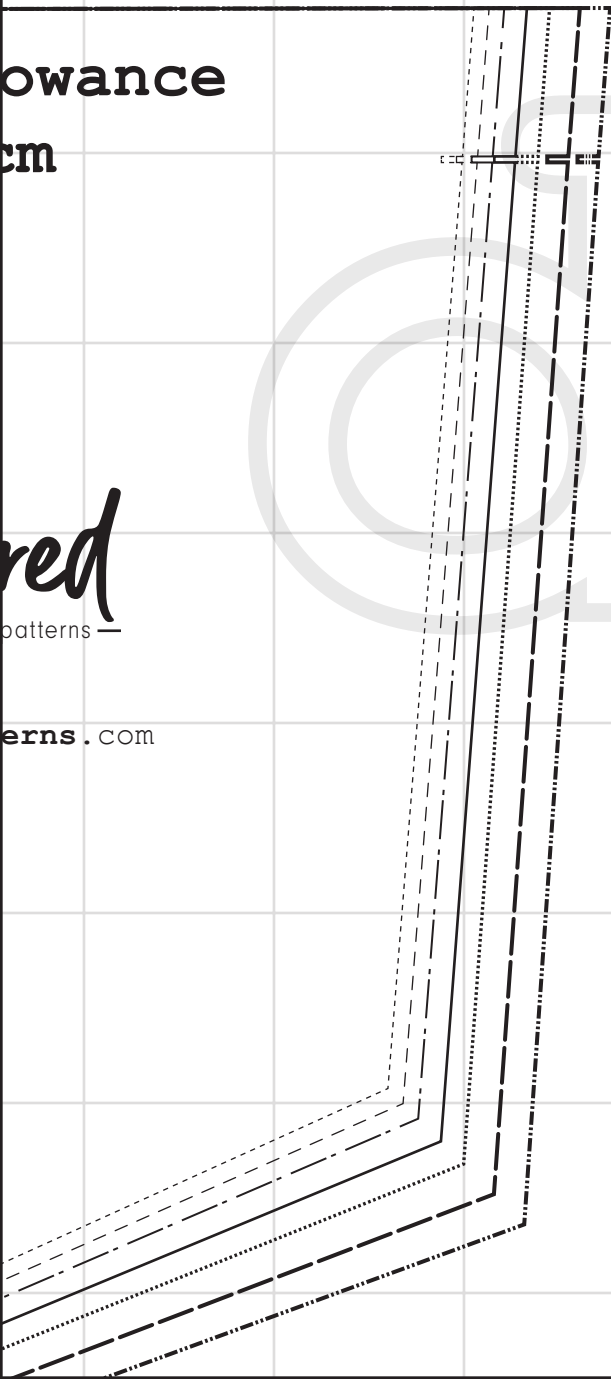

Cut on this line

013

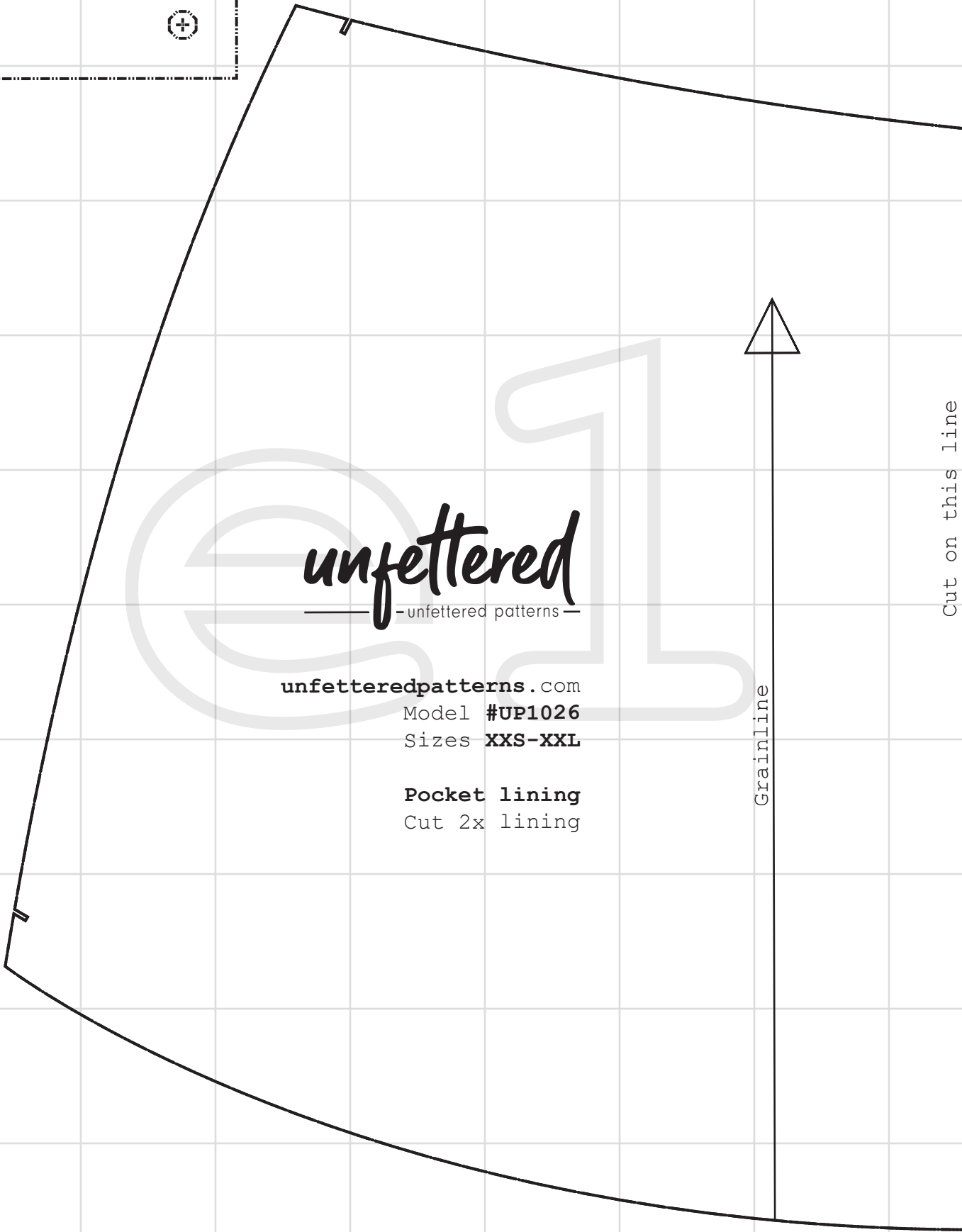
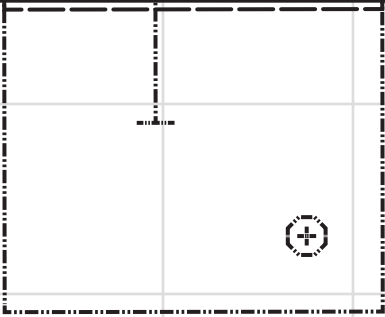

Grainline

unfettered
— unfettered patterns —

unfetteredpatterns.com

Model #UP1026

Sizes XXS-XXL

Pocket lining

Cut 2x lining

Cut on this line

